



Weston Collection

4 seater modular sofa shown in Kenzo Oatmeal (Cover 1), Milo Linen (Cover 2), Jace Cedar (Cover 3), Harlequin Mink (Cover 4), Harlequin Mink (Cover 5) and Jace Cedar (Cover 6).

2 seater sofa shown in Kenzo Chocolate (Cover 1), Milo Linen (Cover 2), Harlequin Mink (Cover 3) and Jace Cedar (Cover 4). Arc footstool shown in Harlequin Mink (Cover 1).

Colours represented are to be used as a guide only, colour shadings can vary slightly from each roll of fabric. Please refer to manufacturers swatch for more colour options.

foamflex⁺

16/01/2025

WESTON COVER GUIDE: STANDARD BACK

Please use this guide when ordering the following pieces to clarify cover options.

STANDARD BACK - Available with & without studs

LH2, COR, RH2 Corner Group

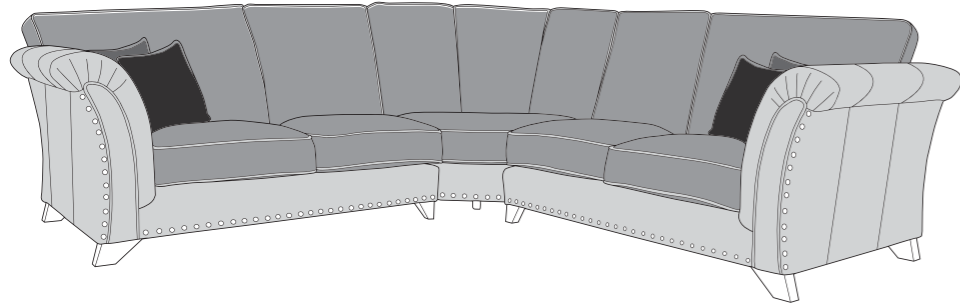

LH2, COR, RH1 Corner Group

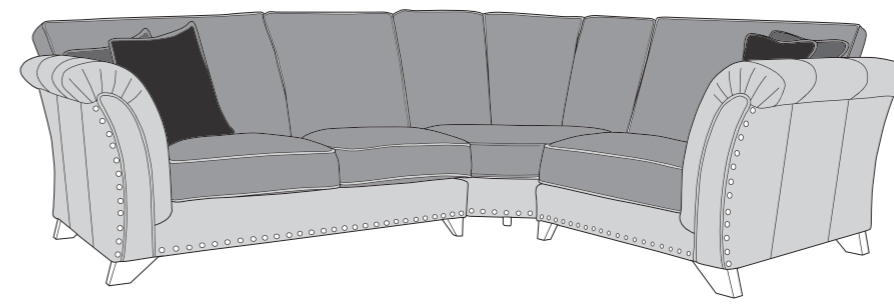

LH1, COR, RH2 Corner Group

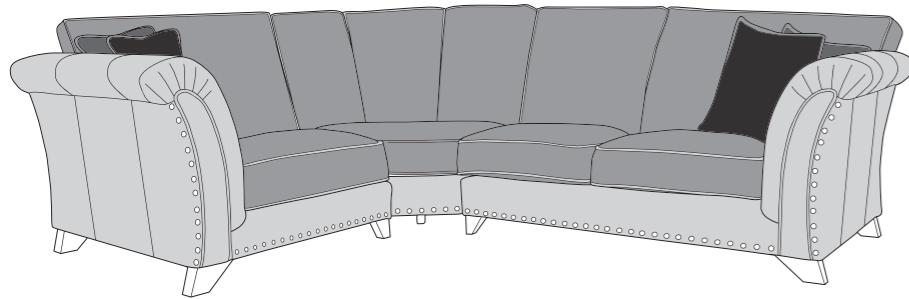

LH1, COR, RH1 Corner Group

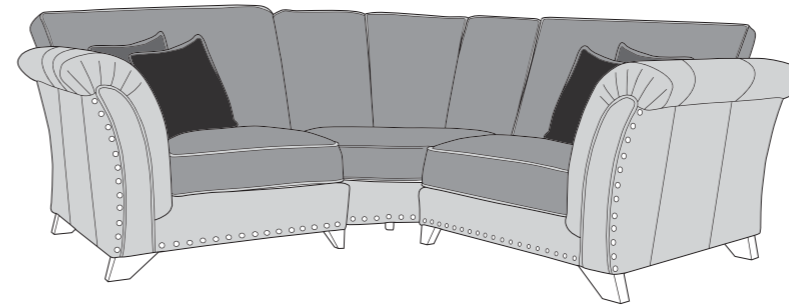

Armless Unit (ALU)

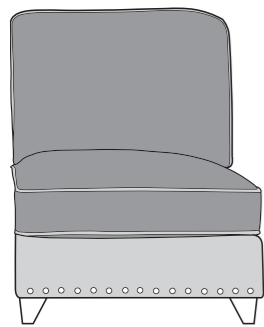

4 Seater Modular Sofa (4MD)

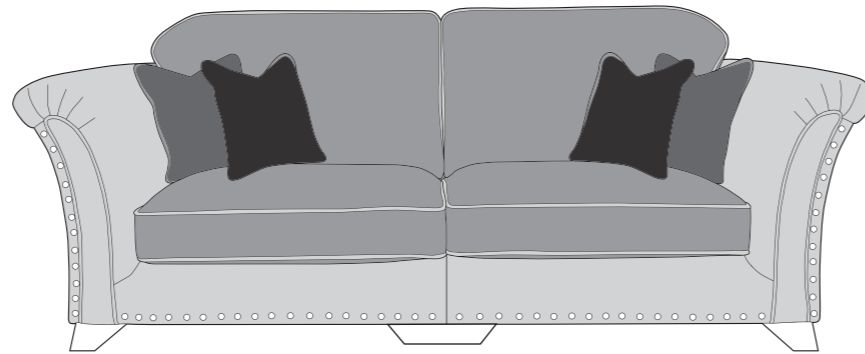

3 Seater Sofa (3ST)

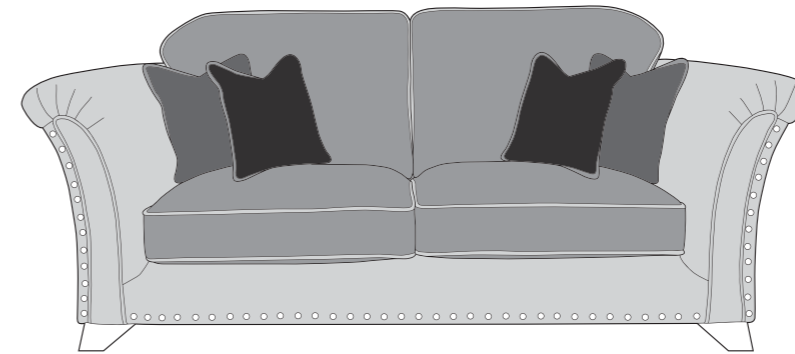

2 Seater Sofa (2ST)

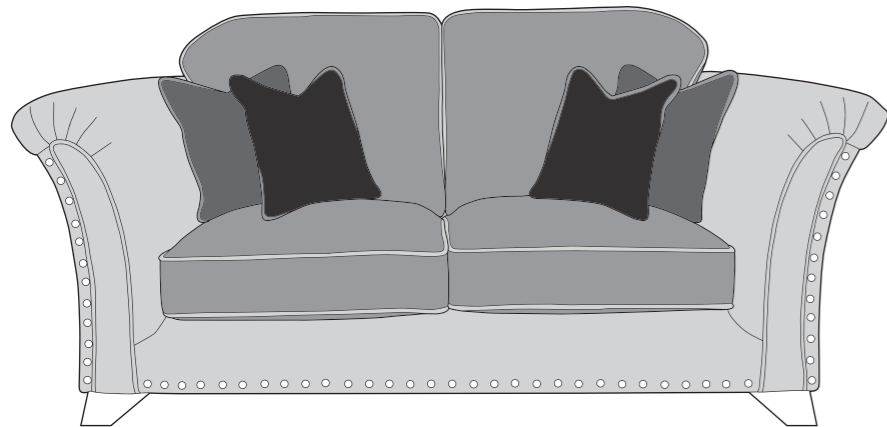



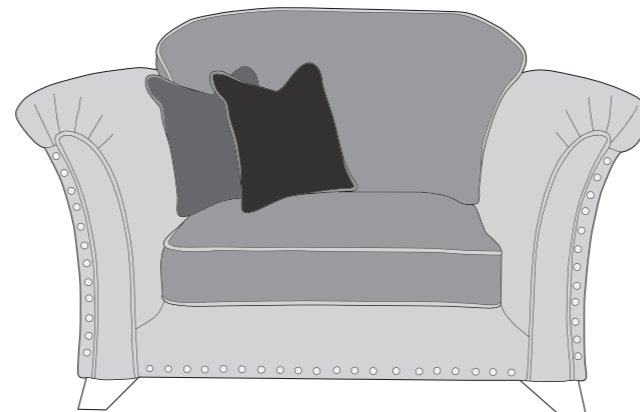

Love Chair (LOV)

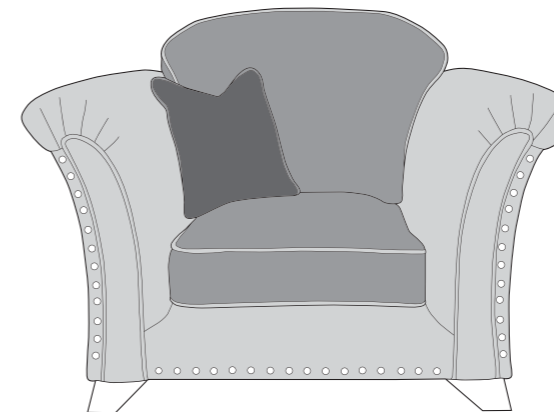

Arm Chair (1ST)



-  **COVER 1**
(OUTER,
SEAT PIPING,
BACK PIPING)
-  **COVER 2**
(INNER,
SCATTER PIPING)
-  **COVER 3**
(SCATTER)
-  **COVER 4**
(SCATTER)

Standard Back Scatter Cushions

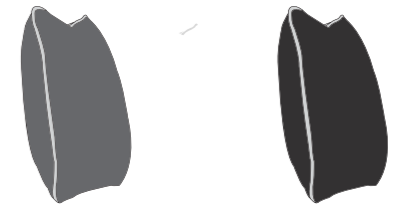

Front = Cover 3
Piping = Cover 2
Back = Cover 3

Front = Cover 4
Piping = Cover 2
Back = Cover 4



WESTON COVER GUIDE: PILLOW BACK

Please use this guide when ordering the following pieces to clarify cover options.

PILLOW BACK - Available with & without studs

LH2, COR, RH2 Corner Group

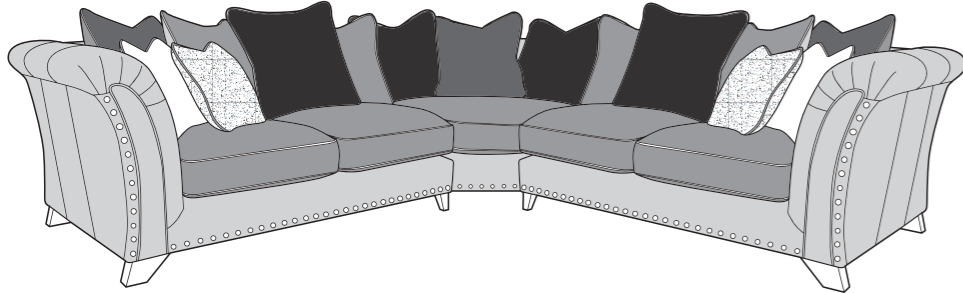

LH2, COR, RH1 Corner Group

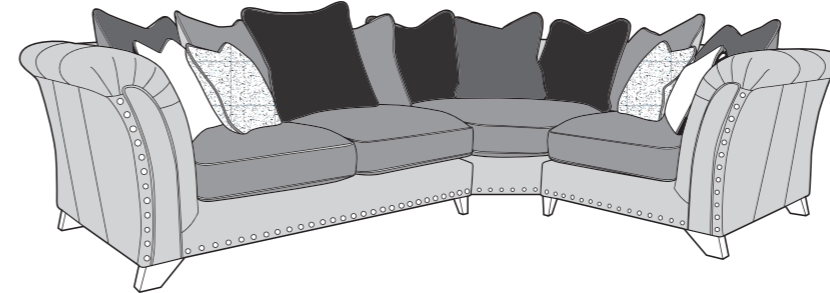

Armless Unit (ALU)

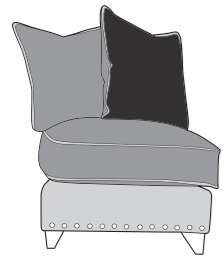

LH1, COR, RH2 Corner Group

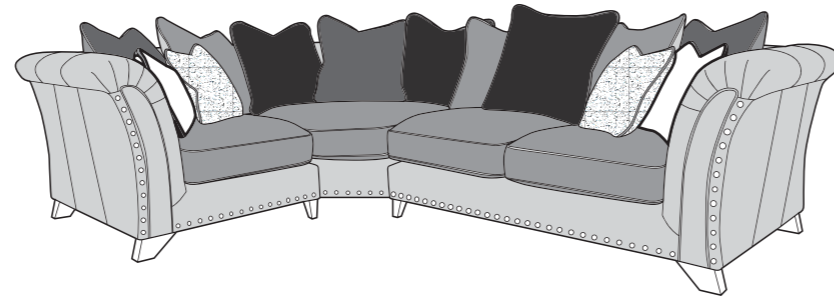

LH1, COR, RH1 Corner Group

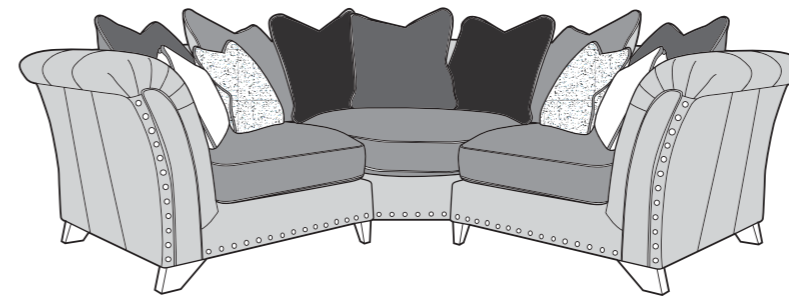

4 Seater Modular Sofa (4MD)

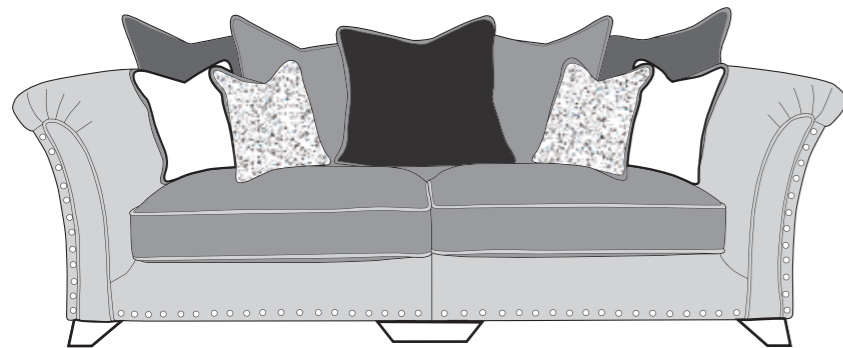

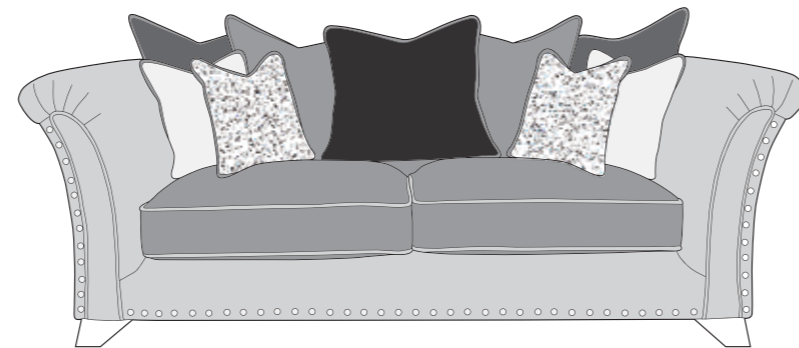

3 Seater Sofa (3ST)

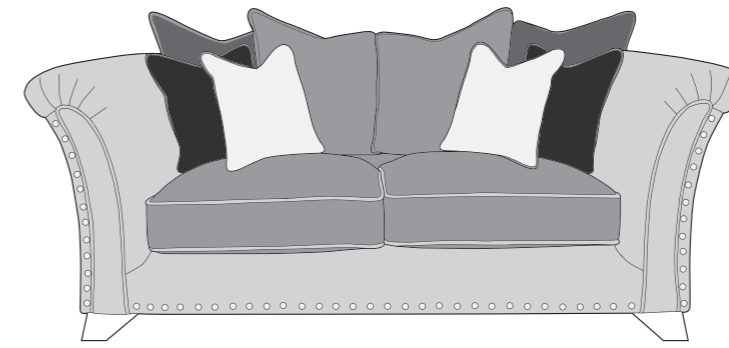

2 Seater Sofa (2ST)



-  **COVER 1**
(OUTER, PILLOW, SEAT PIPING)
-  **COVER 2**
(INNER, PILLOW, PILLOW PIPING, SCATTER PIPING)
-  **COVER 3**
(PILLOW)
-  **COVER 4**
(PILLOW, SCATTER)
-  **COVER 5**
(SCATTER)
-  **COVER 6**
(SCATTER)

Pillow Back Cushions

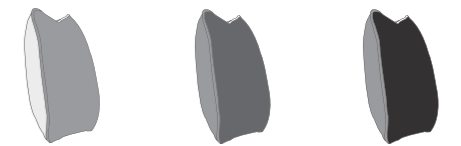

Front = Cover 2 Front = Cover 3 Front = Cover 4
 Piping = Cover 2 Piping = Cover 2 Piping = Cover 2
 Back = Cover 1 Back = Cover 2 Back = Cover 2

Pillow Back Scatter Cushions

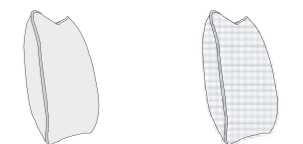

Front = Cover 5 Front = Cover 6
 Piping = Cover 2 Piping = Cover 2
 Back = Cover 5 Back = Cover 6

SUGGESTED ACCENT PIECES

Throne Accent Chair (ACH)

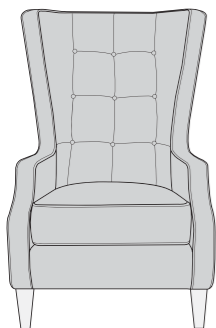

Throne Footstool (FST)

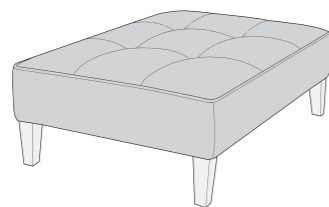

Weston Footstool (FSS)

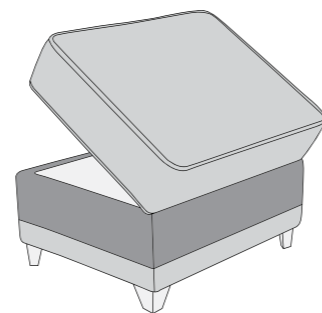

MANUFACTURER MEMBER



WESTON DIMENSIONS (CM)

AVAILABLE PIECES	HEIGHT 1	OUTBACK HEIGHT	WIDTH 2	DEPTH 3	ARM HEIGHT	SEAT HEIGHT 4	SEAT DEPTH (STANDARD) 5	SEAT DEPTH (PILLOW) 5	SEAT WIDTH 6	ACCESS DIAGONAL 7	WEIGHT (KG)	SCATTER CUSHION NO.
LH2, COR, RH2 CORNER GROUP	92	79	289	289	81	49	N/A	N/A	N/A	402	148	4
LH1, COR, RH2 or RH1, COR, LH2 CORNER GROUP	92	79	289	223	81	49	N/A	N/A	N/A	117	135.5	4
LH1, COR, RH1 CORNER GROUP	92	79	223	223	81	49	N/A	N/A	N/A	N/A	126	4
LH2, COR, RH2 CORNER GROUP	92	79	289	289	81	49	N/A	N/A	N/A	402	148	4
LH2/RH2 UNIT	92	79	167	104	81	49	52	52	135	194	52.5	2
LH1/RH1 UNIT	92	79	101	104	81	49	52	52	69	141	40	2
ALU - ARMLESS UNIT	92	79	70	104	N/A	49	52		70	121	24.5	N/A
COR - CORNER UNIT	92	79	122	122	N/A	49	65	65	N/A	173	43	N/A
4ML/4MR UNIT (4MD)	92	79	126	104	81	49	52	52	94	159	46.5	2
SEATING CONFIGURATIONS												
4 SEATER MODULAR SOFA (4MD)	92	79	252	104	81	49	52	52	188	273	93	4
3 SEATER SOFA (3ST)	92	79	219	104	81	49	52	52	155	239	76.5	4
2 SEATER SOFA (2ST)	92	79	200	104	81	49	52	52	136	220	66	4
LOVE CHAIR (LOV)	92	79	158	104	81	49	52	52	91	158	55.5	2
ARM CHAIR (1ST)	92	79	128	104	81	49	52	52	62	160	49.5	1
ACCENT PIECES												
THRONE CHAIR (ACH)	122	N/A	73	88	N/A	52	54	N/A	55	102	28.5	N/A
THRONE FOOTSTOOL (FST)	37	N/A	104	73	N/A	N/A	N/A	N/A	N/A	123	12	N/A
WESTON FOOTSTOOL (FSS)	45	N/A	63	50	N/A	N/A	N/A	N/A	N/A	N/A	13	N/A

- * Hardwood & composite board frame.
- * Dowelled, screwed, glued & stapled joinery.
- * Light, Dark & Smokey Grey Wood foot options.

- * Fibre filled backs for added comfort.
- * Feather filled scatters included. 
- * foamflex+ seat interior.

- * Serpentine seat springs & silent wire.
- * Elasticated back webbing.

DIMENSION GUIDE

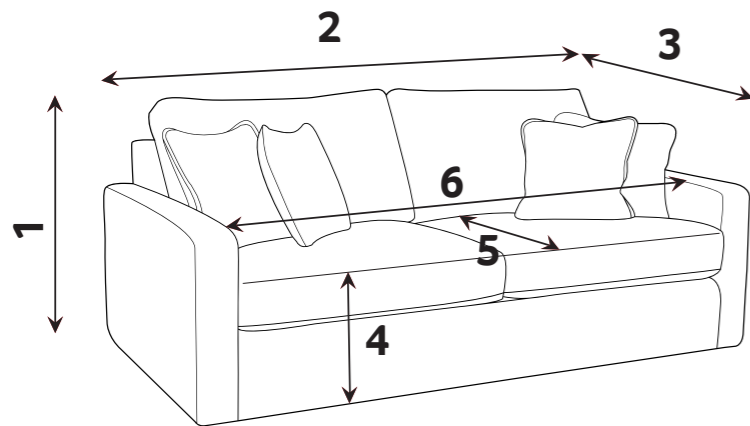

- 1 - HEIGHT
- 2 - WIDTH
- 3 - DEPTH
- 4 - SEAT HEIGHT
- 5 - SEAT DEPTH (STD & PILLOW)
- 6 - SEAT WIDTH
- 7 - DIAGONAL ACCESS

Check the diagonal access dimension to ensure furniture will fit in your home.

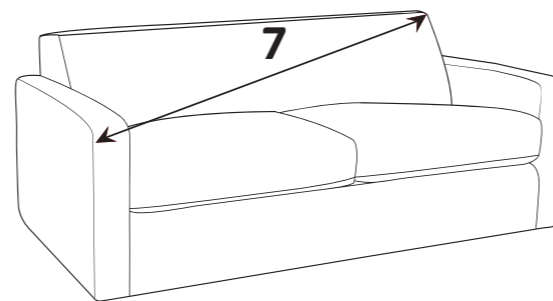

Illustrations used for reference only.

foamflex+

Our expertly engineered foam seat interior gives you the comfort of fibre with the retention of foam.

CARE GUIDE

To improve the longevity of your hand-made furniture, we recommend rotating cushions (where applicable).

For further information on maintaining your furniture, please refer to the Care Guide located under the seat platform.

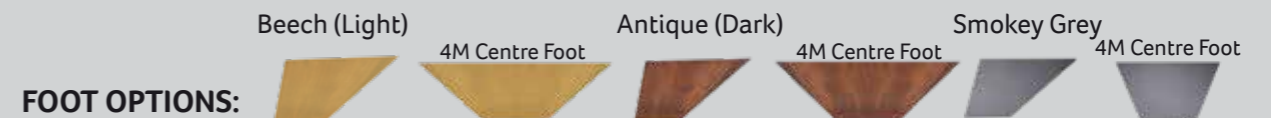
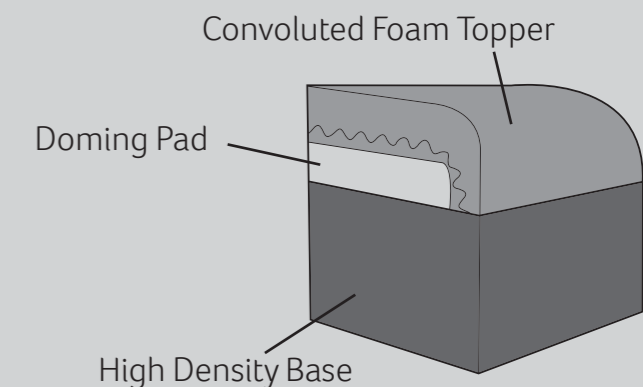

FOOT OPTIONS:

Please note : All dimensions are approximate. Allow tolerance of +/- 2.5cm.

Wood is a natural product and will vary in shade/colour from item to item. Feet may require fitting.



See terms & conditions

16/01/2025